

DQG

WINDOWS FOR LIFE

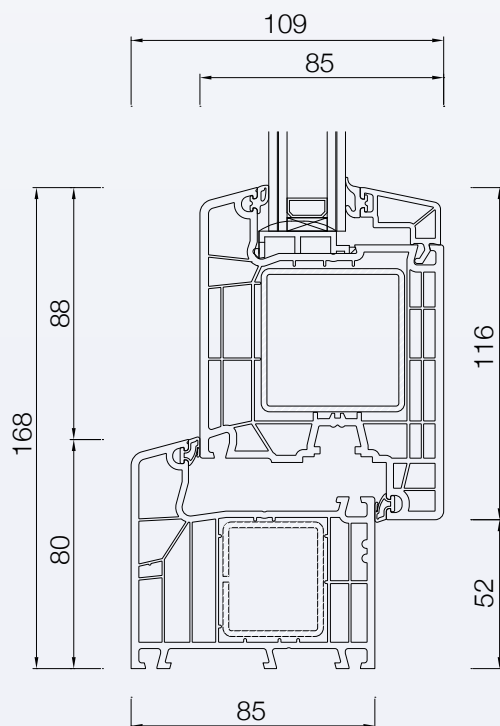

DQG 85 SMART PORTONCINI

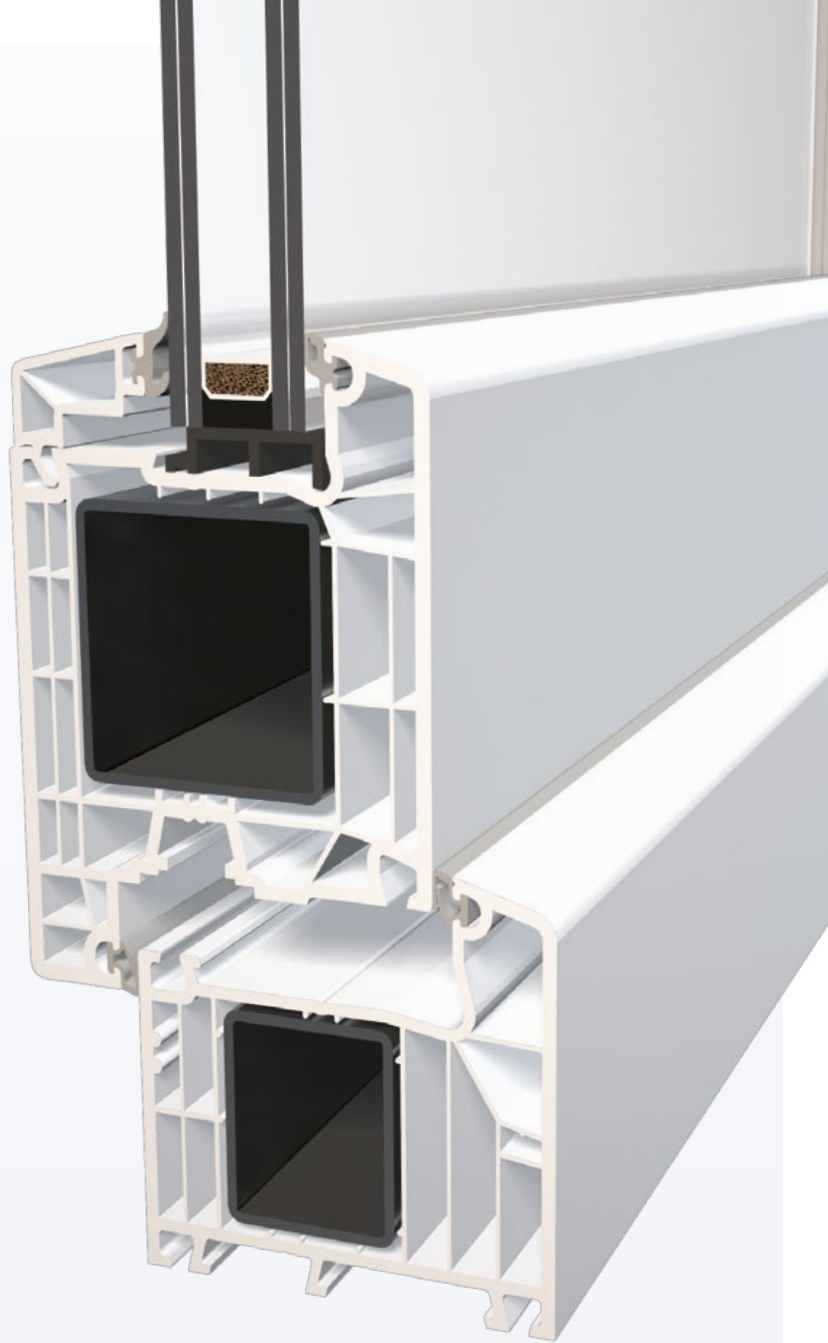

ENTRANCE DOORS / PORTES D'ENTRÉE





SISTEMI / SYSTEMS / SYSTÉMES

 SISTEMA System / Système	
TELAIO Frame Châssis	85 x 80 mm
ANTA Sash for window/door window Vantail pour fenêtre/porte-fenêtre	85 x 116 mm
CAMERE Panels Chambres	6
RINFORZI Reinforcements Renforts	In acciaio zincato a caldo Hot-dip galvanised steel tubes En acier galvanisé à chaud
GUARNIZIONI Seals Joints	2
SPESSORE VETRO FINO A Glass thickness up to Épaisseur vitre jusqu'à	51 mm

 TIPOLOGIE Types / Types	 REALIZZABILI Possible / Réalisables
FISSO Fixed Fixe	✓
FINESTRA Window Fenêtre	—
WASISTAS Bottom hinged window Vasistas	—
PORTA FINESTRA French door Porte-fenêtre	—
PORTA BALCONE Balcony door Porte de balcon	—
PORTONCINO D'INGRESSO Entrance door Porte d'entrée	✓
SCORREVOLE ALZANTE Lift and slide door Coulissante à levage	—
SCORREVOLE RIENTRANTE Tilt and turn sliding system Coulissante à translation	—
SCORREVOLE PARALLELO Parallel sliding door Coulissante parallèle	—
APERTURA ESTERNA Outward opening Ouverture extérieure	✓

 PRESTAZIONI Performances / Performances	 FINO ALLA CLASSE Up to Class / Jusqu'à la Classe	 NORMA Standard / Norme
PERMEABILITÀ ALL'ARIA Air permeability Perméabilité à l'air	4	DIN EN 12207
TENUTA ALL'ACQUA Watertightness Étanchéité à l'eau	8A	DIN EN 12208
RESISTENZA AL CARICO DEL VENTO Wind load resistance Résistance à la charge du vent	C4	DIN EN 12210

 ISOLAMENTO ACUSTICO* Acoustic insulation* / Isolation phonique*		dB	 NORMA Standard / Norme
CON OPPORTUNO VETRAGGIO FINO A With suitable glazing up to Avec vitrage approprié jusqu'à		43	EN ISO 717-1

* Valori relativi ad un infisso campione (1110 x 2220 mm)

* Values for a sample window (1110 x 2220 mm)

* Valeurs relatives à une huisserie spécimen (1110 x 2220 mm)

 ISOLAMENTO TERMICO Thermal insulation / Isolation thermique				
 NODO Mullion / Meneau	 VETRO Glass / Vitre	 SERRAMENTO** Window** / Huisserie**	 NORMA Standard / Norme	
1,30 W/m ² k	 DOPPIO VETRO Double glazing Double vitrage	1,00 W/m ² k	1,20 W/m ² k	DIN EN ISO 10077 - 1 Canalina Warm Edge - $\Psi = 0,041$ W/mk Warm Edge spacer - $\Psi = 0,041$ W/mk Intercalaire Warm Edge - $\Psi = 0,041$ W/mk
	 TRIPLO VETRO Triple glazing Triple vitrage	0,50 W/m ² k	0,87 W/m ² k	

** Valori calcolati su un infisso campione (1230 x 2180 mm)

** Values calculated on a sample window (1230 x 2180 mm)

** Valeurs calculées sur une huisserie spécimen (1230 x 2180 mm)